

MCU base

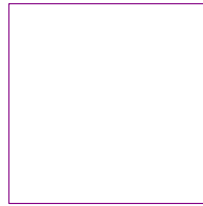

File: mcubase.kicad_sch

Power

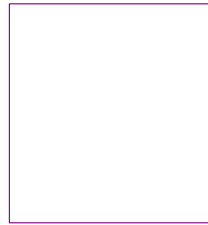

File: power.kicad_sch

Motors





File: motors.kicad_sch

ADC

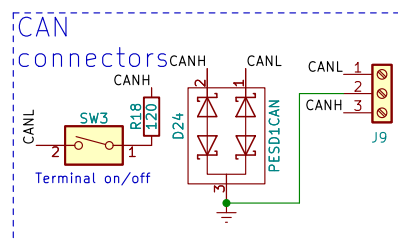
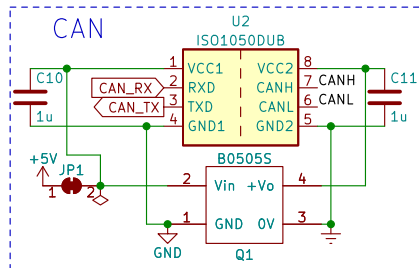
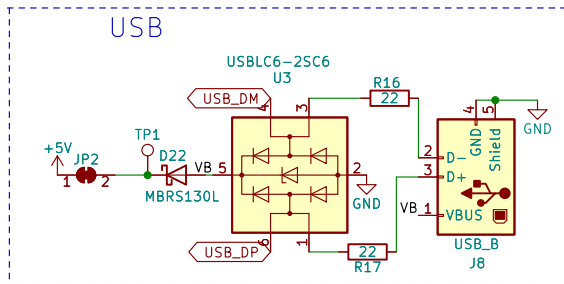

File: ADC.kicad_sch



-  H1 MountingHole
-  H2 MountingHole
-  H3 MountingHole
-  H4 MountingHole

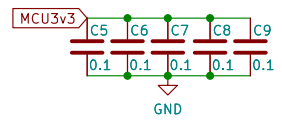
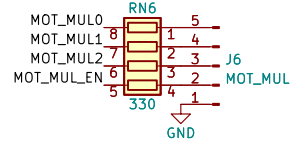
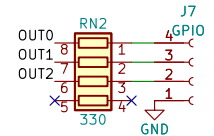
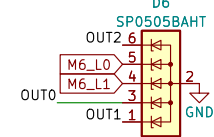
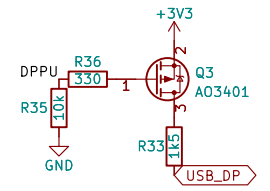
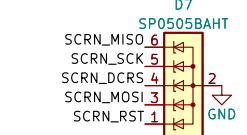
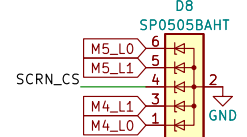
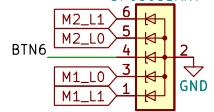
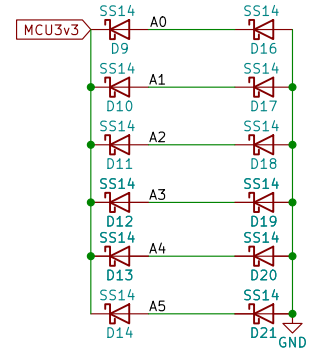
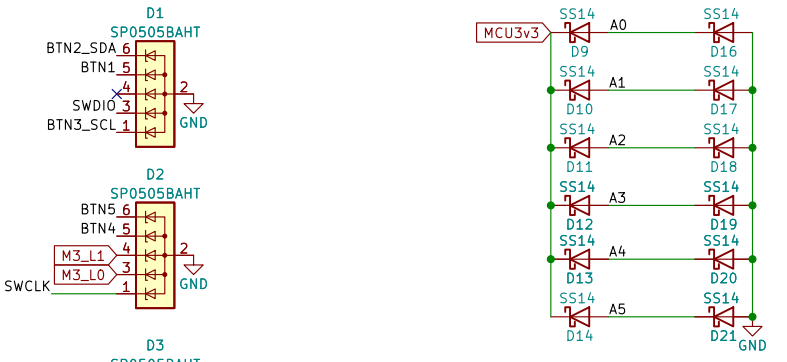
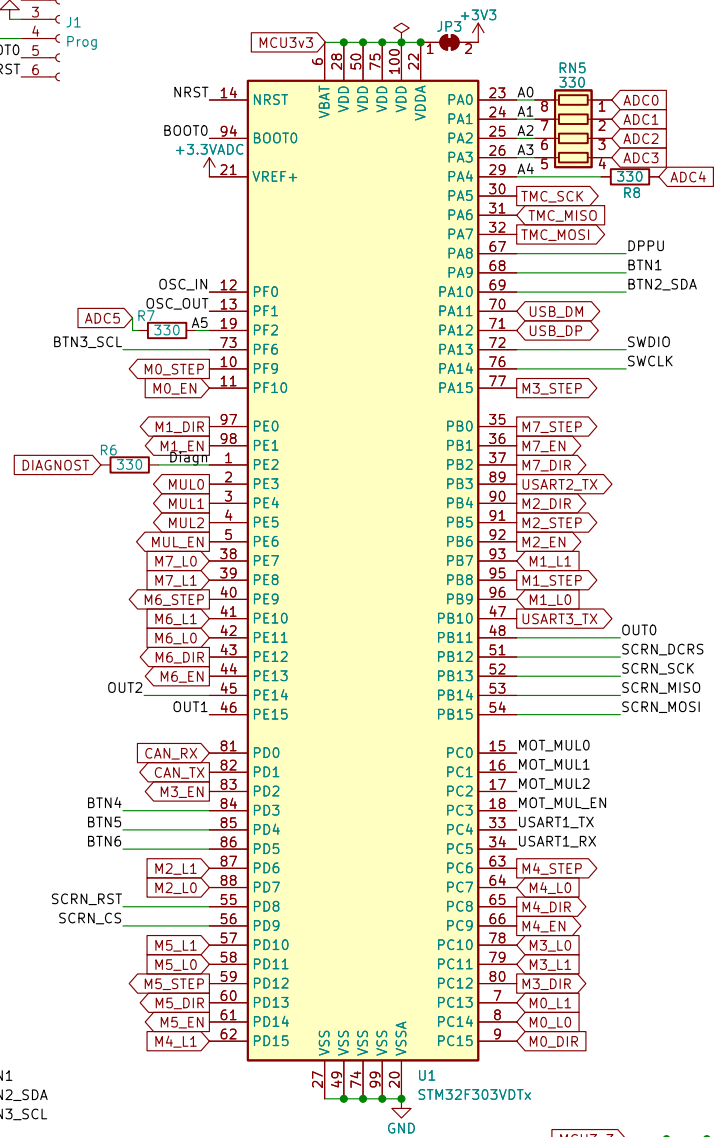
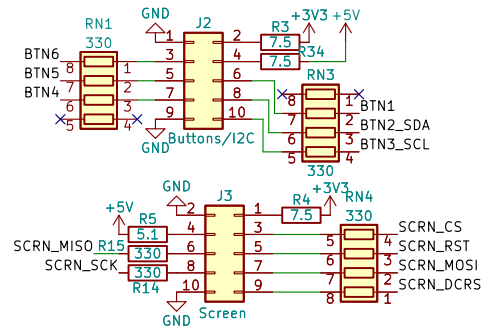
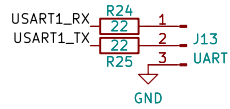
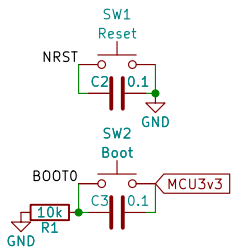
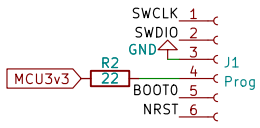
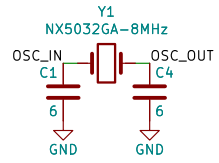

0 - motor's voltage / 10
1 - +5V/2
2,3,4,5 - external

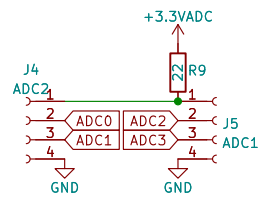

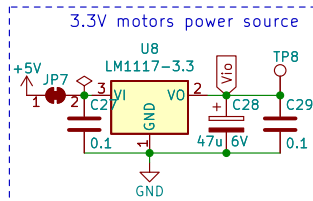
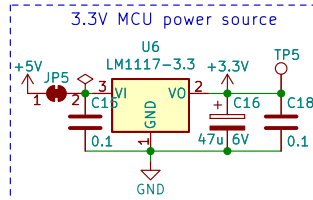
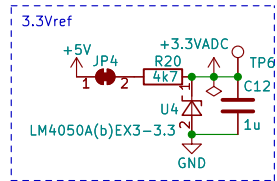
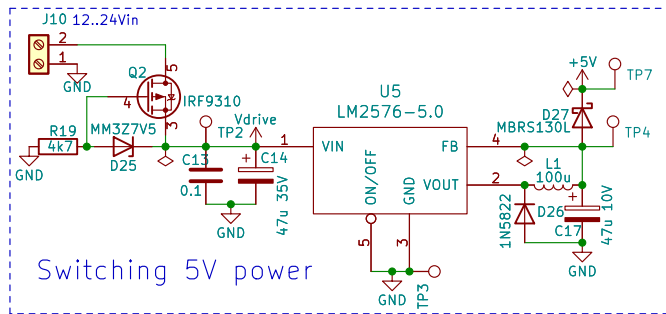

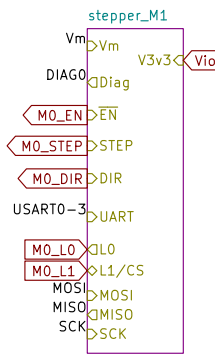
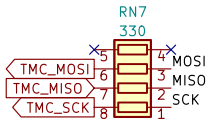
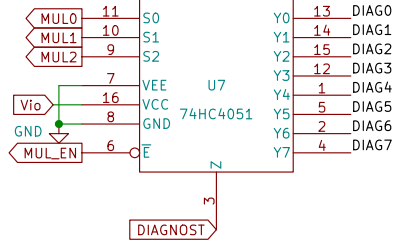
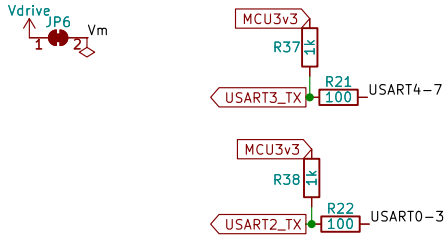

File: stepper_M.kicad_sch

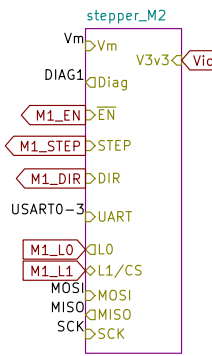

File: stepper_M.kicad_sch

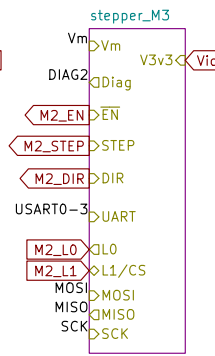

File: stepper_M.kicad_sch

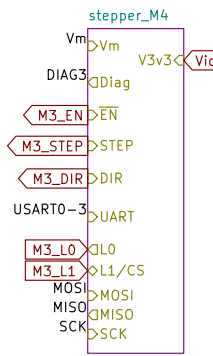

File: stepper_M.kicad_sch

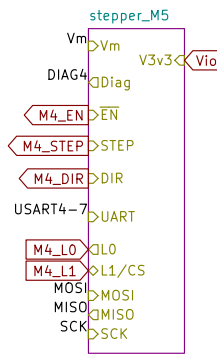

File: stepper_M.kicad_sch

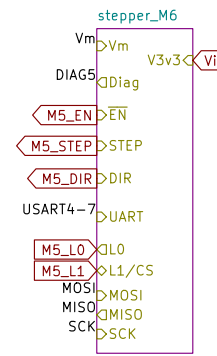

File: stepper_M.kicad_sch

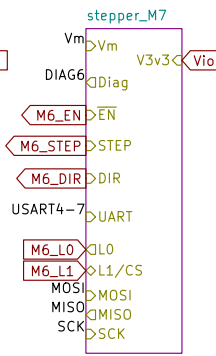

File: stepper_M.kicad_sch

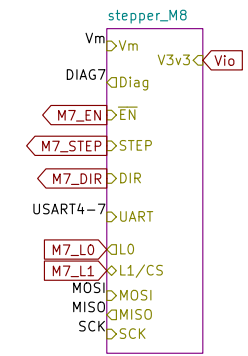

File: stepper_M.kicad_sch

